



Movexx **T6000-Clean Room**
PARTS & OPTIONS
2021 v1

Specifications

Technical details

Frame	Stainless steel, vibration sanding & varnishing
Drive	24V DC, 1100W, 90 rpm
Weight	700 kg (1543.2 lbs)
Max. pulling force	3500 N
Weight trailer	6000 kg (13,227.7 lbs)
Battery	Built in
Speed Max.	4,2 km/h (2.7 mph)
Drive wheels	Non marking full rubber Cleanroom, Ø 250x80mm (9.8 x 3.1 in)
Adze height	750-1198 mm (29.5 - 47.2 in)
Noise level	68,5 dB
To use from	-10° / 40° C (14° / 104° F)

Dimensions

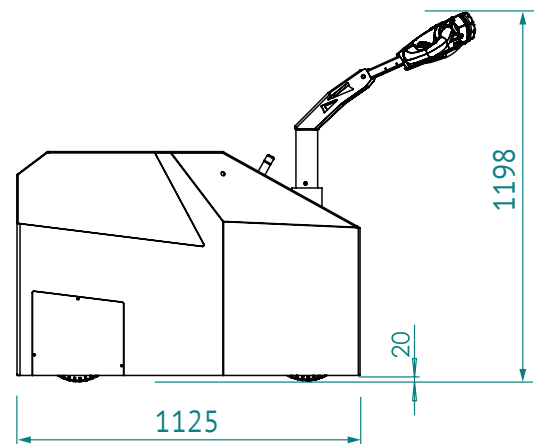
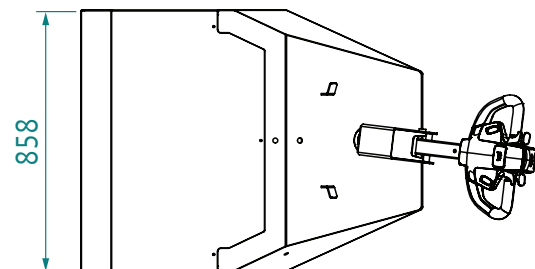

© 2021 Movexx International B.V. The images shown are used for illustration purposes only and may differ from the products indicated. No rights can therefore be derived from it. Printing errors are subjected to change. The datasheet is the confidential product of Movexx International B.V. and no portion of this datasheet may be copied, performed, or redistributed without the express written authority of Movexx International B.V.

Standard parts

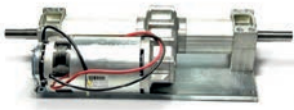

Motor 1100W / 90rpm
(6911450X) with brake
Item number M6003



LED battery indicator
(build-in)
Item number M0318



Battery AGM-VRLA (set)
24V / 160Ah
2x Item number M2102-SP



Charger (internal)
AGM battery 24V / 20A
+ external indicator
Item number M6004



Drive wheel, Cleanroom
full rubber, non-marking
Gray Ø 250 x 80mm
Item number M0249



Steering wheel, Cleanroom
full rubber, non-marking
Gray Ø 250 x 80mm
Item number M0594

Standard parts



Adjustable tiller head



Belly button RED
Item number M0121-BBUT



2 programmable speeds

Options



Horn 90dB for
stainless steel
tiller head supp.
Item number OPT0414



Horn 103dB
Item number OPT0059

Options



Emergency stop complete
Item number OPT0063



Strobe light for
stainless steel
tiller head supp.
Item number OPT0415



Audio signal
(while driving)
Item number OPT0253

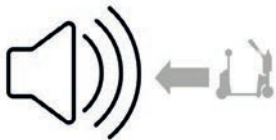

Audio signal
(driving backward)
Item number OPT0254



Hour tracker
Item number OPT0056



Antistatic strip
Item number OPT0058

Options



Code lock
Item number OPT0068



Preparation electric hook
Item number OPT0143



Ignition key (unequal)
Item number OPT0145



Ignition key 701 (equal)
Item number OPT0146



On/off rotary switch
Item number OPT0016



Parking floorlabel Ø 60 cm
Item number OPT0245

Options



Customized programming
Please indicate
specific settings
Item number OPT0170



Programmer for Italsea
Item number D0003



Urgent order purchase
Item number SPOED

Batteries & Chargers



Battery AGM-VRLA (set)
24V / 160Ah
2x Item number M2102-SP



Charger (internal)
AGM battery 24V / 20A
+ external indicator
Item number M6004

Adapters



Base part heavy hook 90°
(lowered)
Item number H7070

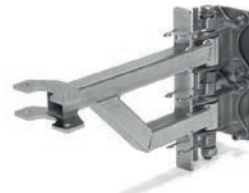

Base part heavy hook 90°
(raised)
Item number H7080

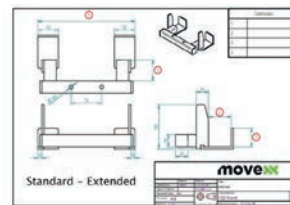

Customized hook
Please complete
corresponding sheet
Item number HA5000

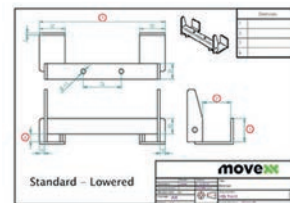

Customized hook (low)
Please complete
corresponding sheet
Item number HB5000

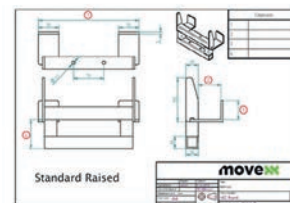

Customized hook (raised)
Please complete
corresponding sheet
Item number HC5000

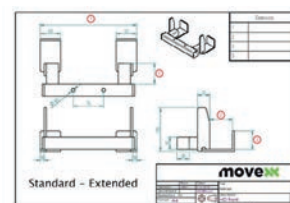

Customized hook
(extended)
Please complete
corresponding sheet
Item number HD5000

Adapters

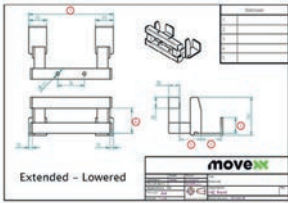

Customized hook
(extended/low)
*Please complete
corresponding sheet*
Item number HE5000

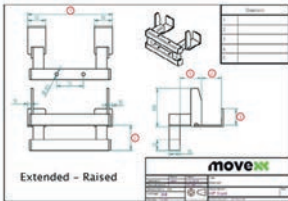

Customized hook
(extended/raised)
*Please complete
corresponding sheet*
Item number HF5000



Pen for drawbar Ø16
Item number H0064

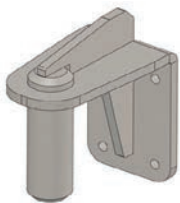

Pen for drawbar Ø35
Item number H0144



Pen for drawbar Ø20
Item number H0161



Towbar for Movexx
e-frame
(suitable for OPT0067)
Item number H0070

Adapters

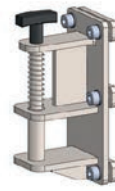

Spring hitch, pen Ø16
Item number H0120



Pen for drawbar Ø15
Item number H0071



Pen for drawbar Ø10
Item number H0072



Folding hook Ø16
Item number H0128-D16



Folding hook Ø20
Item number H0128-D20



Folding hook Ø25
Item number H0128-D25

Adapters



Folding hook Ø27
Item number H0128-D27



Folding hook Ø32
Item number H0128-D32



Folding hook Ø35
Item number H0128-D35

Most common spareparts



Belly button RED
Item number M0121-BBUT



Switch buttons (2x) green
Item number M0121-KNOP-GROEN



Switch tiller head
excl. buttons
Item number M0121-FLIPPER



Feather/shaft Throttle
Item number M0121-4

Most common spareparts



Battery AGM-VRLA (set)
24V / 160Ah
2x Item number M2102-SP



Charger (internal)
AGM battery 24V / 20A
+ external indicator
Item number M6004



Switch FAST/SLOW
tiller head green
Item number M0121-SPEED-GROEN



Switch ON/OFF
tiller head green
Item number M0121-AANUIT-GROEN

Adapters



Torsion spring for hook
Item number M0117-SP



Italsea drive controller
in 24V / 36 bat,
in 60A / I_{max} 250A
Item number M6002-SP



Carbon brushes (set of 4)
for Motor 1100W
Item number M1040



LED battery indicator
(build-in)
Item number M0318



Cable harness 2
Item number M1132



Fuse 5A
Item number M0506

Adapters



Fuse Mega 200A
Item number M6001



Chassis cable charger
Item no M0158-Stekker



Parallel key 8x7x40 mm
Item number M6016



Drive wheel Cleanroom
full rubber, non-marking
Gray Ø 250 x 80mm
Item number M0249



Steering wheel, Cleanroom
full rubber, non-marking
Gray Ø 250 x 80mm
Item number M0594

applications



moveXX
driven by brain power

Generatorstraat 17-19
3903 LH Veenendaal
The Netherlands

T +31 (0)318 519900
E info@movexx.com
W www.movexx.com

