



Movexx **T6000**  
PARTS & OPTIONS  
**2020** v2

## Specifications

### Technical details

|                           |  |
|---------------------------|--|
| <b>Frame</b>              | Steel, powder coated                     |
| <b>Drive</b>              | 24V DC, 1100W, 90 rpm                    |
| <b>Weight</b>             | 700 kg (1543.2 lbs)                      |
| <b>Max. pulling force</b> | 3500 N                                   |
| <b>Weight trailer</b>     | 6000 kg (13,227.7 lbs)                   |
| <b>Battery</b>            | Built in                                 |
| <b>Speed Max.</b>         | 4,2 km/h (2.7 mph)                       |
| <b>Drive wheels</b>       | Full rubber Ø 250 x 80 mm (9.8 x 3.1 in) |
| <b>Adze height</b>        | 750-1269 mm (29.5 - 49.6 in)             |
| <b>Noise level</b>        | 68,5 dB                                  |
| <b>To use from</b>        | -10° / 40° C (14° / 104° F)              |

© 2020 Movexx International B.V. The images shown are used for illustration purposes only and may differ from the products indicated. No rights can therefore be derived from it. Printing errors are subjected to change. The datasheet is the confidential product of Movexx International B.V. and no portion of this datasheet may be copied, performed, or redistributed without the express written authority of Movexx International B.V.

## Pulling power (in kg)

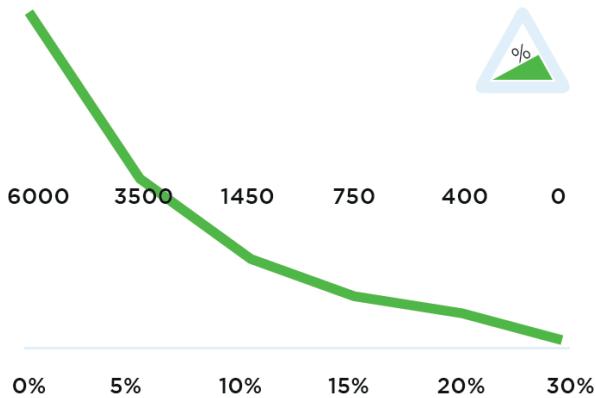

Measured with a trolley with 2 swivel wheels and 2 fixed castors. Wheel Ø 160 mm.

## Dimensions

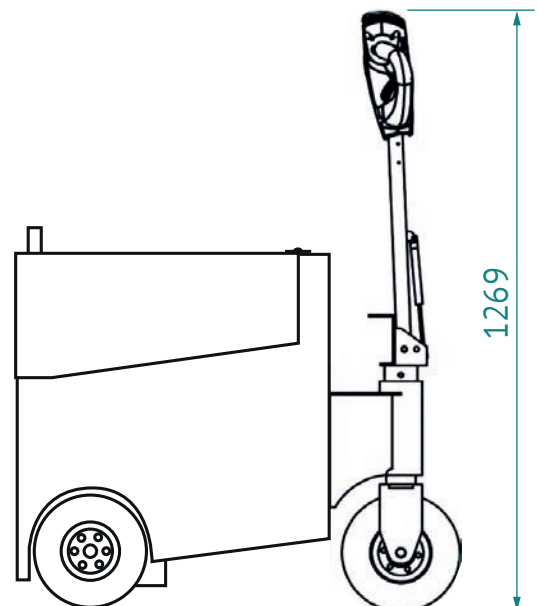
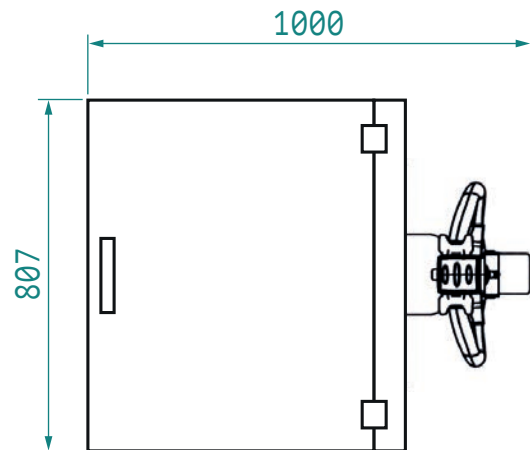

## Standard parts



Motor 1100W / 90rpm  
(6911450X) with brake  
**Item number M6003**



LED battery indicator  
(build-in)  
**Item number M0318**



Battery AGM-VRLA  
24V / 160Ah  
**2x Item number M2102-SP**



Charger (internal)  
AGM battery 24V / 20A  
+ external indicator  
**Item number M6004**



Drive wheel, full rubber  
Black Ø 250 x 80 mm  
**Item number M0248**



Steering wheel, full rubber  
Black Ø 250 x 80 mm  
**Item number M6019**

## Standard parts



Adjustable tiller head  
**Item number M2503**



Belly button RED  
**Item number M0121-BBUT**



2 programmable speeds

## Options



UPGRADE:  
(only with new machines)  
Wheels full rubber,  
non-marking  
Gray 3x Ø 250 x 80 mm  
**Item number OPT0358**



Horn 90dB for  
steel tiller head supp.  
**Item number OPT0057**

## Options



Horn 103dB  
**Item number OPT0059**



Emergency stop complete  
**Item number OPT0063**



Strobe light for  
steel tillerhead supp.  
**Item number OPT0065**



Audio signal  
(while driving)  
**Item number OPT0253**

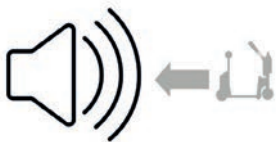

Audio signal  
(driving backward)  
**Item number OPT0254**



Hour tracker  
**Item number OPT0056**

## Options



Antistatic strip  
**Item number OPT0058**



Code lock  
**Item number OPT0068**



Safety fender  
**Item number OPT0079**



Preparation electric hook  
**Item number OPT0143**

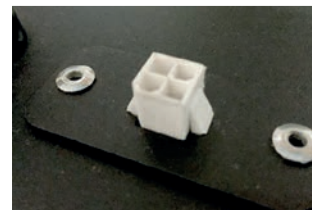

Diagnostic connector  
**Item number OPT0270**



Ignition key (unequal)  
**Item number OPT0145**

## Options



Ignition key 701 (equal)  
**Item number OPT0146**



On/off rotary switch  
**Item number OPT0016**



Parking floorlabel Ø 60 cm  
**Item number OPT0245**



Customized programming  
*Please indicate  
specific settings*  
**Item number OPT0170**



Programmer for Italsea  
**Item number D0003**



Maximum weight  
**Item number OPT0172**

## Options



Drive protection  
**Item number OPT0153**

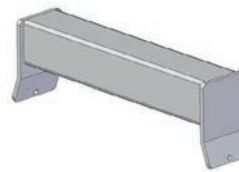

Welding part for trolley  
(profile 50 x 50 mm)  
**Item number OPT0032**



Bolt-on part for trolley  
(profile 50 x 50 mm)  
**Item number OPT0033**



Pushbar  
**Item number OPT0048**



Urgent order purchase  
**Item number SPOED**

## Batteries & Chargers



Battery AGM-VRLA  
24V / 160Ah  
**2x Item number M2102-SP**



Charger (internal)  
AGM battery 24V / 20A  
+ external indicator  
**Item number M6004**

## Adapters

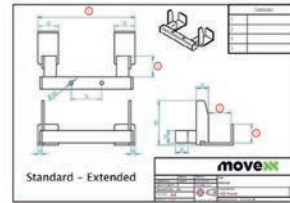

Customized hook  
*Please complete  
corresponding sheet*  
**Item number HA5000**

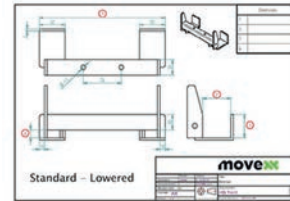

Customized hook (low)  
*Please complete  
corresponding sheet*  
**Item number HB5000**

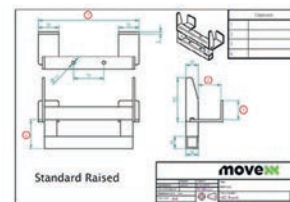

Customized hook (raised)  
*Please complete  
corresponding sheet*  
**Item number HC5000**

## Adapters



Base part heavy hook 90°  
(lowered)  
**Item number H7070**

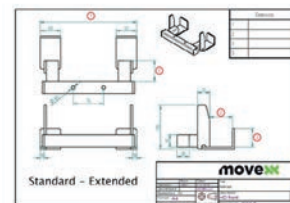

Customized hook  
(extended)  
*Please complete  
corresponding sheet*  
**Item number HD5000**

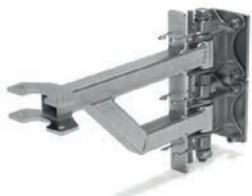

Base part heavy hook 90°  
(raised)  
**Item number H7080**

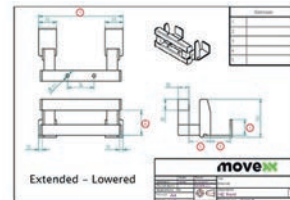

Customized hook  
(extended/low)  
*Please complete  
corresponding sheet*  
**Item number HE5000**



Base part hook 90°  
(manual controle)  
**Item number H7090**

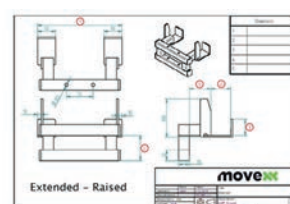

Customized hook  
(extended/raised)  
*Please complete  
corresponding sheet*  
**Item number HF5000**

## Adapters



Hitchball Ø 50 mm  
(incl. adapter)  
**Item number H0068**



Hook for LKE platform-  
wagon (type X)  
**Item number H0076**



Hook K-Hartwall dolly  
(DOS1617/1636, 90°)  
**Item number H0083**



Electric heavy duty  
lifting module  
**Item number OPT0271**



Electric locking module  
for hook  
**Item number OPT0129**



Pen for drawbar Ø16  
**Item number H0064**

## Adapters

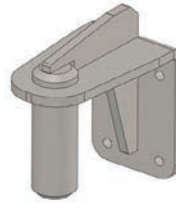

Pen for drawbar Ø35  
**Item number H0144**

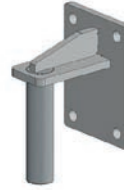

Pen for drawbar Ø20  
**Item number H0161**



Pen for drawbar Ø25  
**Item number H0166**



Trailer coupling, pen Ø25  
**Item number H0062**



Trailer coupling, pen Ø32  
**Item number H0146**



Trailer coupling, pen Ø25  
**Item number H0149**

## Adapters



Towbar for Movexx  
e-frame  
(suitable for OPT0067)  
**Item number H0070**

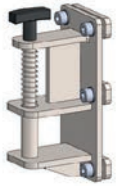

Spring hitch, pen Ø16  
**Item number H0120**



Pen for drawbar Ø15  
**Item number H0071**



Pen for drawbar Ø10  
**Item number H0072**



Folding hook Ø16  
**Item number H0128-D16**



Folding hook Ø20  
**Item number H0128-D20**

## Adapters



Folding hook Ø25  
**Item number H0128-D25**



Folding hook Ø27  
**Item number H0128-D27**



Folding hook Ø32  
**Item number H0128-D32**



Folding hook Ø35  
**Item number H0128-D35**

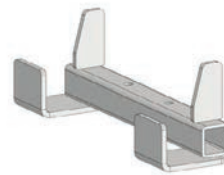

HA270.43.40.0.0  
Hook for 40 mm profile  
(K-Hartwall pallet trolley;  
DOS1870)  
**Item number H0003**

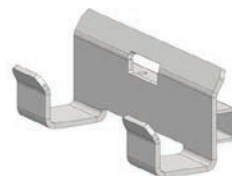

**€ 194,—**  
HA245.53.45.15.0  
Hook for 50 mm profile  
(heavy duty)  
**Item number H0004**



## Adapters

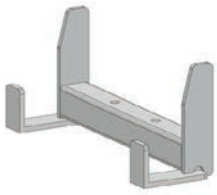

HA250.43.35.0.0  
Hook for 40 mm profile  
**Item number H0051**

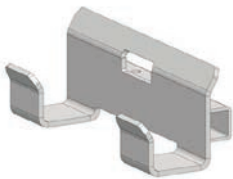

HB245.43.30.5.0  
Hook for 40 mm profile  
**Item number H0054**

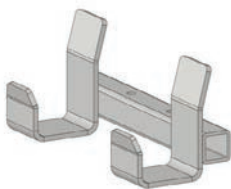

HB245.60.45.30.0  
Hook for FEIL plastic floor trolley  
**Item number H0092**



HC250.28.25.0.0  
Hook for 25 mm profile  
**Item number H0094**

## Most common spareparts



Charger (internal)  
AGM battery 24V / 20A  
+ external indicator  
**Item number M6004**



Belly button RED  
**Item number M0121-BBUT**



Switch buttons (2x) green  
**Item number M0121-KNOP-GROEN**



Switch tiller head  
excl. buttons  
**Item number M0121-FLIPPER**



Feather/shaft Throttle  
**Item number M0121-4**



Switch FAST/SLOW  
tiller head green  
**Item number M0121-SPEED-GROEN**

## Most common spareparts



Battery AGM-VRLA  
24V / 160Ah  
**2x Item number M2102-SP**

## Most common spareparts



Switch ON/OFF  
tiller head green  
**Item number**  
**M0121-AANUIT-GROEN**



Torsion spring for hook  
**Item number** **M0116-SP**



Italsea drive controller  
in 24V / 36 bat,  
in 60A / I<sub>max</sub> 250A  
**Item number** **M6002-SP**



Carbon brushes (set of 4)  
for Motor 1100W  
**Item number** **M1040**



LED battery indicator  
(build-in)  
**Item number** **M0318**



Cable harness 2  
**Item number** **M1132**

## Most common spareparts



Fuse 5A  
**Item number** **M0506**



Fuse Mega 200A  
**Item number** **M6001**



Chassis cable charger  
**Item no** **M0158-Stekker**



Parallel key 8x7x40 mm  
**Item number** **M6016**



Drive wheel, full rubber  
Black Ø 250 x 80 mm  
**Item number** **M0248**



Drive wheel  
full rubber, non-marking  
Gray Ø 250 x 80 mm  
**Item number** **M0115**

## Most common spareparts



Steering wheel, full rubber  
Black Ø 250 x 80 mm  
**Item number M6019**



Steering wheel  
full rubber, non-marking  
Gray Ø 250 x 80 mm  
**Item number M0696**

# applications



**movexx**  
driven by brain power

Generatorstraat 17-19  
3903 LH Veenendaal  
The Netherlands

**T** +31 (0)318 519900  
**E** info@movexx.com  
**W** www.movexx.com

