



Specifications

Technical details

Frame	Steel, powder coated
Drive	24V DC, 600W, 100 rpm
Weight	300 kg (661.4 lbs)
Max. pulling force	3200 N
Weight trailer	3500 kg (7716.2 lbs)
Battery	Built in
Speed Max.	4,7 km/h (2.9 mph)
Drive wheels	Full rubber Ø 250 x 80 mm (9.8 x 3.1 in)
Adze height	750-1269 mm (29.5 - 50 in)
Noise level	68,5 dB
To use from	-10° / 40° C (14° / 104° F)

© 2020 Movexx International B.V. The images shown are used for illustration purposes only and may differ from the products indicated. No rights can therefore be derived from it. Printing errors are subjected to change. The datasheet is the confidential product of Movexx International B.V. and no portion of this datasheet may be copied, performed, or redistributed without the express written authority of Movexx International B.V.

Pulling power (in kg)

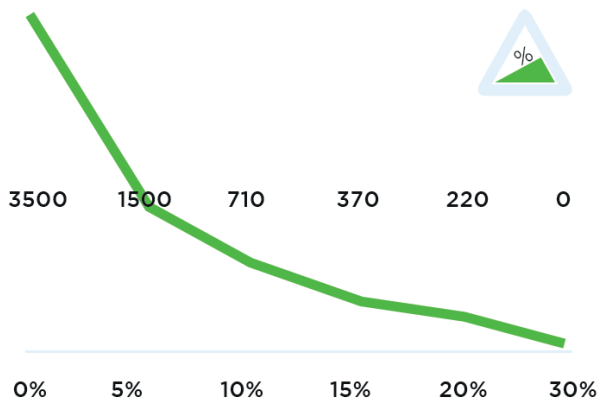

Measured with a trolley with 2 swivel wheels and 2 fixed castors. Wheel Ø 160 mm.

Dimensions

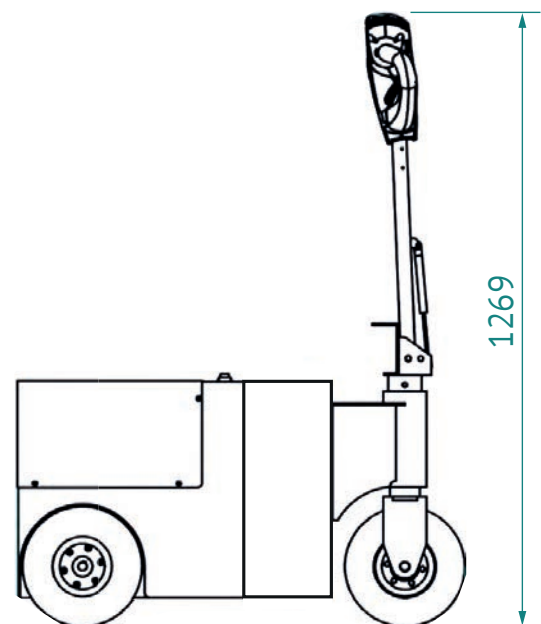
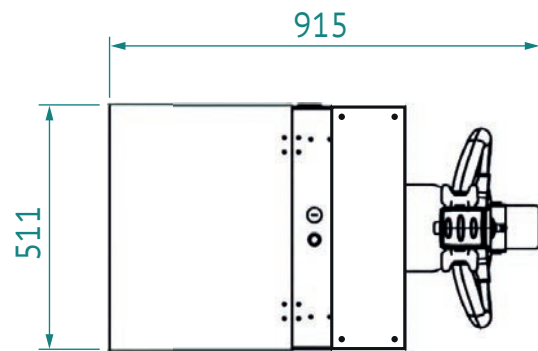

Standard parts



Motor 600W / 100rpm
(6911413X) with brake
Item number M2098



LED battery indicator
(build-in)
Item number M0318



Battery AGM-VRLA
24V / 80Ah
Item number M2102-SP



Charger (internal)
AGM battery 24V / 10A
+ external indicator
Item number M2134



Drive wheel, full rubber
Black Ø 250 x 80 mm
Item number M0248



Steering wheel, full rubber
Black Ø 250 x 80 mm
Item number M6019

Standard parts



Adjustable tiller head
Item number M2503



Belly button RED
Item number M0121-BBUT



2 programmable speeds

Options



UPGRADE:
(only with new machines)
Wheels full rubber,
non-marking
Gray 3x Ø 250 x 80 mm
Item number OPT0358



Horn 90dB for
steel tiller head supp.
Item number OPT0057

Options



Horn 103dB
Item number OPT0059



Emergency stop complete
Item number OPT0063



Strobe light for
steel tiller head supp.
Item number OPT0065



Audio signal
(while driving)
Item number OPT0253

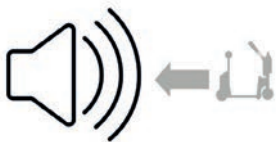

Audio signal
(driving backward)
Item number OPT0254



Hour tracker
Item number OPT0056

Options



Antistatic strip
Item number OPT0058



Code lock
Item number OPT0068



Safety fender
Item number OPT0079



Preparation electric hook
Item number OPT0143

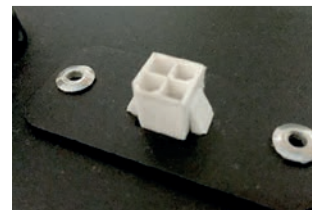

Diagnostic connector
Item number OPT0270



Ignition key (unequal)
Item number OPT0145

Options



Ignition key 701 (equal)
Item number OPT0146



On/off rotary switch
Item number OPT0016



Parking floorlabel Ø 60 cm
Item number OPT0245



Customized programming
*Please indicate
specific settings*
Item number OPT0170



Programmer for Italsea
Item number D0003



Maximum weight
Item number OPT0172

Options

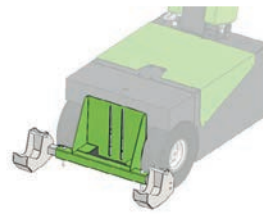

Adaptor for shopping trolley (90°)
Item number OPT0324

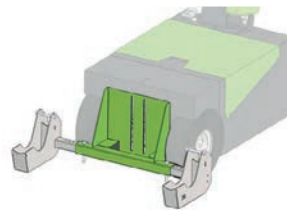

Adaptor for airport trolley (90°)
Item number OPT0327



Conversion to push machine
Item number OPT0201



Drive protection
Item number OPT0153

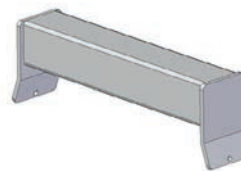

Welding part for trolley (profile 50 x 50 mm)
Item number OPT0032



Bolt-on part for trolley (profile 50 x 50 mm)
Item number OPT0033

Options



Pushbar
Item number OPT0048



Urgent order purchase
Item number SPOED



Frontcontrol
Item number OPT0380



Preparation charging station roll-on/off
Item number OPT0352

Batteries and Chargers



Charger (internal)
AGM battery 24V / 10A
+ external indicator
Item number M2134



UPGRADE:
(only with new machines)
Battery Lithium + charger
25.6V / 120Ah (LiFePO4)
Item number OPT0459



AGM Charging station
roll-on/off (incl. 1 battery
pack 24V / 80Ah)
Item number OPT0071



Lithium Charging station
roll-on/off (incl. 1 battery
pack 25.6V / 120Ah)
Item number OPT0460

Batteries & Chargers



Battery AGM-VRLA
24V / 80Ah
Item number M2102-SP

Adapters



Base part hook 90°
Item number H7030

Adapters



Base part hook 90°
(double spring)
Item number H7040



Base part heavy hook 90°
(lowered)
Item number H7070

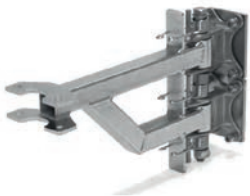

Base part heavy hook 90°
(raised)
Item number H7080



Base part hook 90°
(manual controle)
Item number H7090

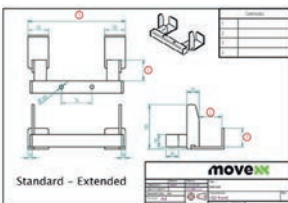

Customized hook
*Please complete
corresponding sheet*
Item number HA5000

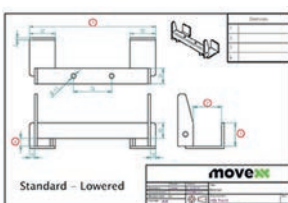

Customized hook (low)
*Please complete
corresponding sheet*
Item number HB5000

Adapters

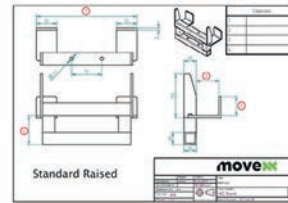

Customized hook (raised)
*Please complete
corresponding sheet*
Item number HC5000

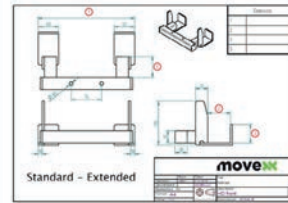

Customized hook
(extended)
*Please complete
corresponding sheet*
Item number HD5000

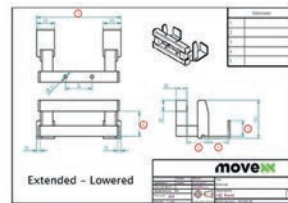

Customized hook
(extended/low)
*Please complete
corresponding sheet*
Item number HE5000

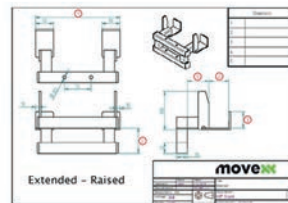

Customized hook
(extended/raised)
*Please complete
corresponding sheet*
Item number HF5000



Hitchball Ø 50 mm
(incl. adapter)
Item number H0068



Hook for LKE platform-
wagon (type X)
Item number H0076

Adapters



Hook K-Hartwall dolly
(DOS1617/1636, 90°)
Item number H0083



Electric heavy duty
lifting module
Item number OPT0271



Electric locking module
for hook
Item number OPT0129



Pen for drawbar Ø16
Item number H0064

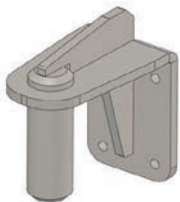

Pen for drawbar Ø35
Item number H0144



Pen for drawbar Ø20
Item number H0161

Adapters



Pen for drawbar Ø25
Item number H0166



Trailer coupling, pen Ø25
Item number H0062



Trailer coupling, pen Ø32
Item number H0146

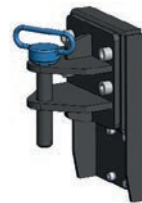

Trailer coupling, pen Ø25
Item number H0149



Towbar for Movexx
e-frame
(suitable for OPT0067)
Item number H0070

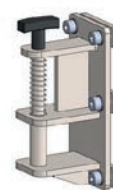

Spring hitch, pen Ø16
Item number H0120

Adapters



Pen for drawbar Ø15
Item number H0071



Pen for drawbar Ø10
Item number H0072



Folding hook
for flower trolley
Item number OPT0099



Folding hook Ø16
Item number H0128-D16



Folding hook Ø20
Item number H0128-D20



Folding hook Ø25
Item number H0128-D25

Adapters



Folding hook Ø27
Item number H0128-D27



Folding hook Ø32
Item number H0128-D32



Folding hook Ø35
Item number H0128-D35

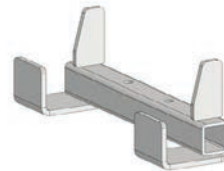

HA270.43.40.0.0
Hook for 40 mm profile
(K-Hartwall pallet trolley;
DOS1870)
Item number H0003

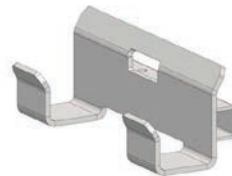

HA245.53.45.15.0
Hook for 50 mm profile
(heavy duty)
Item number H0004

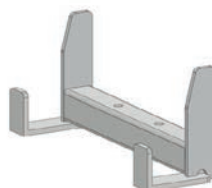

HA250.43.35.0.0
Hook for 40 mm profile
Item number H0051

Adapters

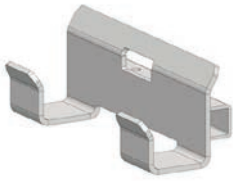

HB245.43.30.5.0
Hook for 40 mm profile
Item number H0054

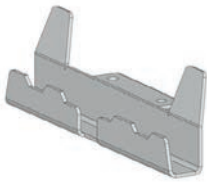

HA250.23.27.0.0
Hook for 20 mm profile
Item number H0067

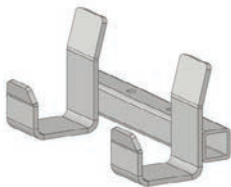

HB245.60.45.30.0
Hook for FEIL plastic floor trolley
Item number H0092

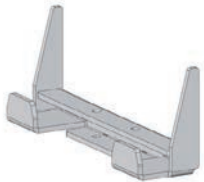

HC250.28.25.0.0
Hook for 25 mm profile
Item number H0094

Most common spareparts



Battery AGM-VRLA
24V / 80Ah
Item number M2102-SP



Charger (internal)
AGM battery 24V / 10A
+ external indicator
Item number M2134



Belly button RED
Item number M0121-BBUT



Switch buttons (2x) green
Item number M0121-KNOP-GROEN



Switch tiller head
excl. buttons
Item number M0121-FLIPPER



Feather/shaft Throttle
Item number M0121-4

Most common spareparts



Switch FAST/SLOW
tiller head green
Item number
M0121-SPEED-GROEN



Switch ON/OFF
tillerhead green
Item number
M0121-AANUIT-GROEN



Torsion spring for hook
Item number **M0116-SP**



Italsea drive controller
in 24V / 36 bat,
in 30A / I_{max} 120A
Item number **M2128-SP**



Carbon brushes (set of 4)
for Motor 600W
Item number **M1037**



LED battery indicator
(build-in)
Item number **M0318**

Most common spareparts



Cable harness 2
Item number **M1132**



Fuse 5A
Item number **M0506**



Fuse Maxi 80A
Item number **M0191**



Chassis cable charger
Item no **M0158-Stekker**



Drive wheel ,full rubber
Black Ø 250 x 80 mm
Item number **M0248**



Drive wheel
full rubber, non-marking
Gray Ø 250 x 80 mm
Item number **M0115**

Most common spareparts



Steering wheel, full rubber
Black Ø 250 x 80 mm
Item number M6019



Steering wheel
full rubber, non-marking
Gray Ø 250 x 80 mm
Item number M0696

applications



movexx
driven by brain power

Generatorstraat 17-19
3903 LH Veenendaal
The Netherlands

T +31 (0)318 519900
E info@movexx.com
W www.movexx.com

