



Movexx **T1000-Platform RVS**
PARTS & OPTIONS
2020 v2

Specifications

Technical details

Frame	Stainless steel, glass pearl blasted
Drive	24V DC, 420W, 140 rpm
Weight	110 kg (242.5 lbs)
Max. pulling force	800 N
Weight trailer	Max. 1000 kg (2204.5 lbs)
Battery	Exchangeable battery pack
Speed	Max. 6,6 km/h (4.1 mph)
Drive wheels	Nonmarking full rubber Clean Room Ø 250 x 80 mm (9.8 x 3.1 in)
Turning radius	2400 mm (94.5 in)
Adze height	750-1261 mm (29.5 - 49.6 in)
Noise level	63,8 dB
To use from	-10° / 40° C (14° / 104° F)

© 2020 Movexx International B.V. The images shown are used for illustration purposes only and may differ from the products indicated. No rights can therefore be derived from it. Printing errors are subjected to change. The datasheet is the confidential product of Movexx International B.V. and no portion of this datasheet may be copied, performed, or redistributed without the express written authority of Movexx International B.V.

Pulling power (in kg)

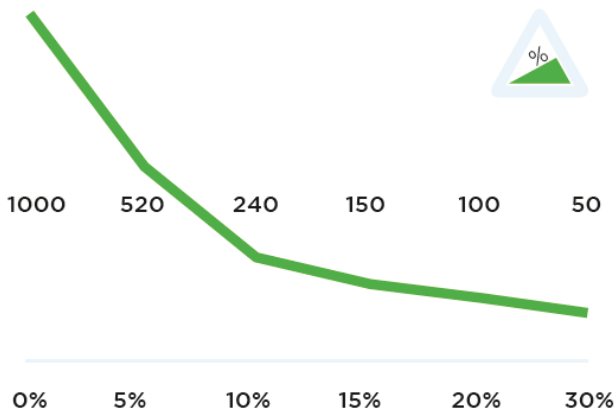

Measured with a trolley with 2 swivel wheels and 2 fixed castors. Wheel Ø 160 mm.

Dimensions

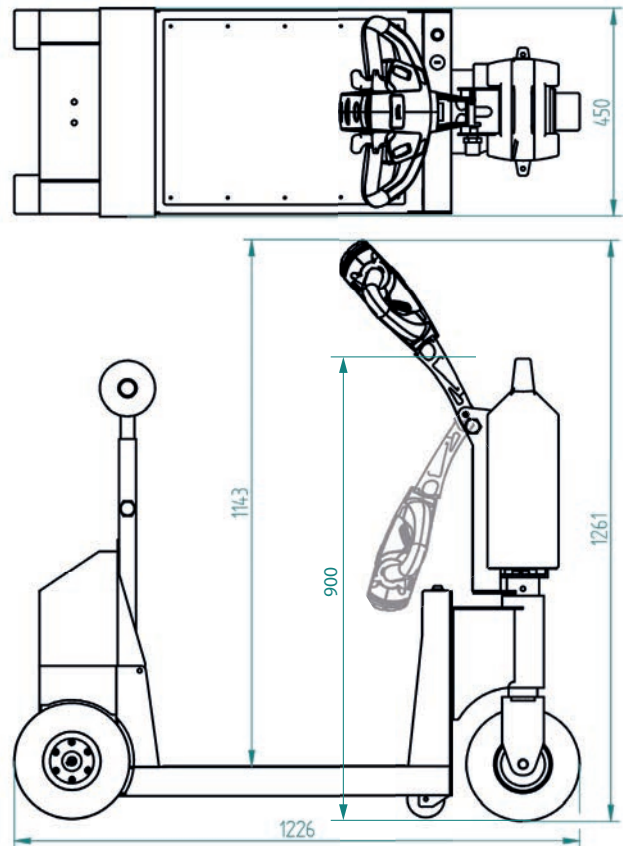

Standard parts



Motor 420W / 140rpm
(6911439X) with brake
Item number M1034



LED battery indicator
Item number M0123



Charger (external)
Lithium battery 25,6V / 10A
Item number OPT0013



Battery Lithium green
(LiFePO4) 25,6V / 36Ah
Item number OPT0106



Drive wheel, Cleanroom
full rubber, non-marking
Grey Ø 250 x 80 mm
Item number M0249



Steering wheel, Cleanroom
full rubber, non-marking
Grey Ø 250 x 80 mm
Item number M0594

Standard parts



Adjustable tiller head
Item number M6021-0500



Belly button BLACK
Item number M0121-3



2 programmable speeds

Options



UPGRADE:
(only with new machines)
Motor 530W / 170rpm
(6911534X) with brake
Item number OPT0025



Extra plug to recharge
the battery
*for on-machine battery
charging*
Item number OPT0001

Options



UPGRADE:
(only with new machines)
drive wheel full rubber
non-marking
Gray 3x Ø 250 x 80 mm
Item number OPT0358



Horn 90dB for
stainless steel
tiller head supp.
Item number OPT0414



Horn 103dB
Item number OPT0059



Emergency stop complete
Item number OPT0063



Strobe light for
stainless steel
tiller head supp.
Item number OPT0415



Strobe light on
stainless steel pole
Item number OPT0426

Options



Audio signal
(while driving)
Item number OPT0253

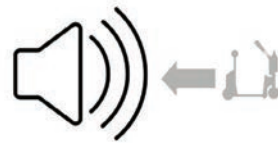

Audio signal
(driving backward)
Item number OPT0254



Hour tracker
Item number OPT0056



Antistatic strip
Item number OPT0058



Code lock
Item number OPT0068



Document holder for
stainless steel
tillerhead supp.
Item number OPT0053

Options



Blue safety spot
Item number 334486



Preparation electric hook
Item number OPT0143

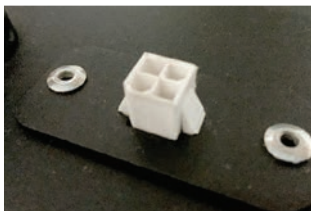

Diagnostic connector
Item number OPT0270



Ignition key (unequal)
Item number OPT0145



Ignition key 701 (equal)
Item number OPT0146



On/off rotary switch
Item number OPT0016

Options



Parking floorlabel Ø 60 cm
Item number OPT0245



Customized programming
Please indicate specific settings
Item number OPT0170



Programmer for Italsea
Item number D0003

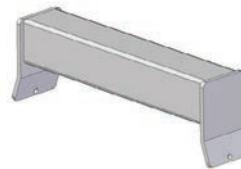

Welding part for trolley
(profile 50 x 50 mm)
Item number OPT0032

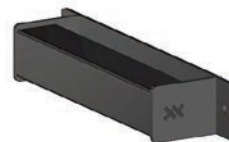

Bolt-on part for trolley
(profile 50 x 50 mm)
Item number OPT0033



Urgent order purchase
Item number SPOED

Options



Detection matt
Item number OPT0334

Batteries and Chargers



Charging station Lithium (5x), incl. Lithium charger 25,6V / 10A
Item number OPT0029

Batteries and Chargers



Charger (external)
Lithium battery 25,6V / 10A
Item number OPT0013



UPGRADE:
(only with new machines)
Wall mounting for charger (for AGM or Lithium)
Item number OPT0261



Battery Lithium green (LiFePO4) 25,6V / 36Ah
Item number OPT0106

Adapters



Base part hook 90° stainless steel
Item number H7031



Wall mounted Lithium charger, incl. Lithium charger 25,6V / 10A
Item number OPT0023



Base part hook 90° (manuel controle)
Item number H7090



Wall mounted Lithium charger, incl. Lithium charger 25,6V / 10A stainless steel
Item nr OPT0023-RVS



Angle limitation hook 90°
Item number OPT0244

Adapters

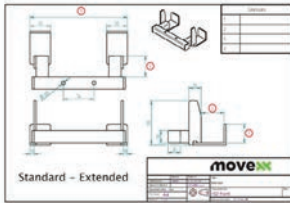

Customized hook
*Please complete
 corresponding sheet*
Item number HA5000

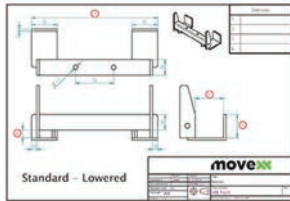

Customized hook (low)
*Please complete
 corresponding sheet*
Item number HB5000

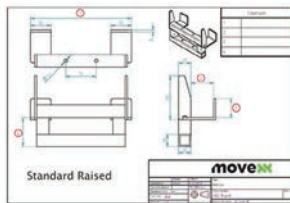

Customized hook (raised)
*Please complete
 corresponding sheet*
Item number HC5000

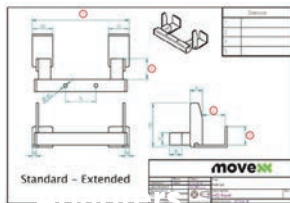

Customized hook
 (extended)
*Please complete
 corresponding sheet*
Item number HD5000

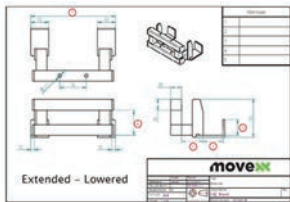

Customized hook
 (extended/low)
*Please complete
 corresponding sheet*
Item number HE5000

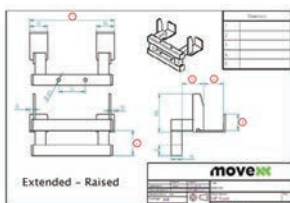

Customized hook
 (extended/raised)
*Please complete
 corresponding sheet*
Item number HF5000

Adapters



Hook for LKE platform-
 wagon (type X)
Item number H0076



Hook K-Hartwall dolly
 (DOS1617/1636, 90°)
Item number H0083



Electric lifting module
 for hook, stainless steel
Item no OPT0050-RVS

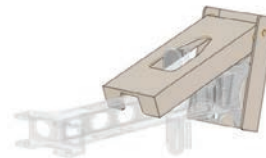

Hook locking system
 stainless steel
Item number OPT0012



Electric locking module
 for hook
Item number OPT0129



Pen for drawbar Ø16
Item number H0064

Adapters

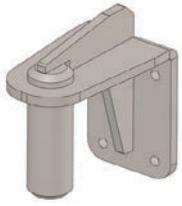

Pen for drawbar Ø35
Item number H0144



Trailer coupling, pen Ø25
Item number H0062



Towbar for Movexx
e-frame
(suitable for OPT0067)
Item number H0070

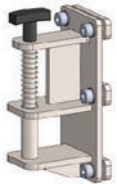

Spring hitch, pen Ø16
Item number H0120



Pen for drawbar Ø15
Item number H0071



Pen for drawbar Ø10
Item number H0072

Adapters



Folding hook
for flower trolley
Item number OPT0099



Folding hook Ø16
Item number H0128-D16



Folding hook Ø20
Item number H0128-D20



Folding hook Ø25
Item number H0128-D25



Folding hook Ø27
Item number H0128-D27



Folding hook Ø32
Item number H0128-D32

Adapters



Folding hook Ø35
Item number H0128-D35

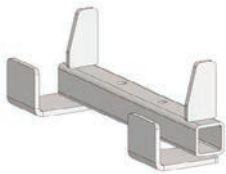

HA270.43.40.0.0
Hook for 40 mm profile
(K-Hartwall pallet trolley;
DOS1870)
Item number H0003

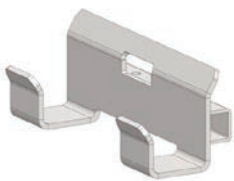

HA245.53.45.15.0
Hook for 50 mm profile
(heavy duty)
Item number H0004

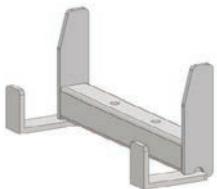

HA250.43.35.0.0
Hook for 40 mm profile
Item number H0051

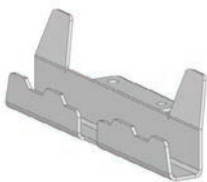

HA250.23.27.0.0
Hook for 20 mm profile
Item number H0067

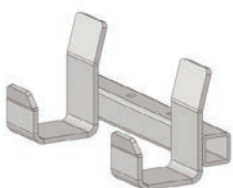

HB245.60.45.30.0
Hook for FEIL plastic floor
trolley
Item number H0092

Adapters



HC250.28.25.0.0
Hook for 25 mm profile
Item number H0094

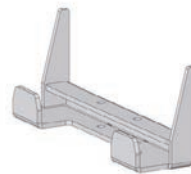

HA250.33.30.0.0
Hook for 30 mm profile
Item number H0095

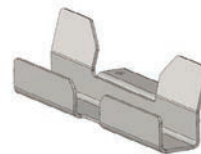

HA250.35.30.0.0
Hook for 30 mm profile
(furniture trolley)
Item number H0097

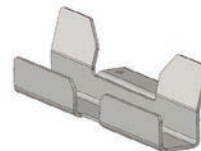

HF242.23.30.15.20
Hook for 20 mm profile
(hospital logistics)
Item number H0116

Most common spareparts



Battery Lithium green
(LiFePO4) 25,6V / 36Ah
Item number OPT0106

Most common spareparts



Charger (external)
Lithium battery 25,6V / 10A
Item number OPT0013



Battery guide
(stainless steel)
Item number M0482



Battery connector SB50
Item number M0105



Belly button BLACK
Item number M0121-3



Switch buttons (2x) green
Item number M0121-KNOP-GROEN



Switch tiller head
excl. buttons
Item number M0121-FLIPPER

Most common spareparts



Feather/shaft Throttle
Item number M0121-4



Switch FAST/SLOW
tiller head green
Item number M0121-SPEED-GROEN



Switch ON/OFF
tiller head green
Item number M0121-AANUIT-GROEN



Plain sleeve bearing
Ø8 / 12 x 6, 16 x 2 mm
Item number M4038



Locking pin
M16 x 1,5 mm
Item number M0001



Torsion spring for hook
(stainless steel)
Item number M0117-SP

Most common spareparts



Italsea drive controller
in 24V / 36 bat,
in 35A / I_{max} 90A
Item number M1124-SP



Carbon brushes (set of 4)
for Motor 420W - 750W
Item number M1037



LED battery indicator
Item number M0123



Cable harness 7
Item number M2304



Fuse 5A
Item number M0506



Fuse Maxi 50A
Item number M0220

Most common spareparts



Drive wheel, Cleanroom
full rubber, non-marking
Gray Ø 250 x 80 mm
Item number M0249



Drive wheel
full rubber, non-marking
Gray Ø 250 x 80 mm
Item number M0115



Steering wheel, Cleanroom
full rubber, non-marking
Gray Ø 250 x 80 mm
Item number M0594



Steering wheel
full rubber, non-marking
Gray Ø 250 x 80 mm
Item number M0696



Castor wheel
Ø 80 mm
Item number M0355

applications



moveXX
driven by brain power

Generatorstraat 17-19
3903 LH Veenendaal
The Netherlands

T +31 (0)318 519900
E info@movexx.com
W www.movexx.com

