



Movexx **T1000-P**
PARTS & OPTIONS
2020 v2

Specifications

Technical details

Frame	Steel, powder coated
Drive	24V DC, 300W, 100 rpm
Weight	89 kg (196.2 lbs)
Max. pulling force	800 N
Weight trailer	Max. 1000 kg (2204.5 lbs)
Battery	Exchangeable battery pack
Speed Max.	3,8 km/h (2.4 mph)
Drive wheels	Vulcalon Ø 200 x 50 mm (7.9 x 2 in)
Adze height	770-1152mm (30.3 - 45.4 in)
Noise level	63,8 dB
To use from	-10° / 40° C (14° / 104° F)
Lifting capacity	500 kg (1102.3 lbs)

© 2020 Movexx International B.V. The images shown are used for illustration purposes only and may differ from the products indicated. No rights can therefore be derived from it. Printing errors are subjected to change. The datasheet is the confidential product of Movexx International B.V. and no portion of this datasheet may be copied, performed, or redistributed without the express written authority of Movexx International B.V.

Pulling power (in kg)

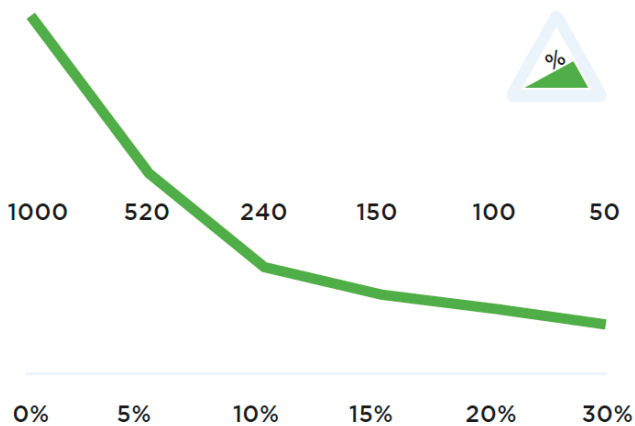

Measured with a trolley with 2 swivel wheels and 2 fixed castors. Wheel Ø 160 mm.

Dimensions

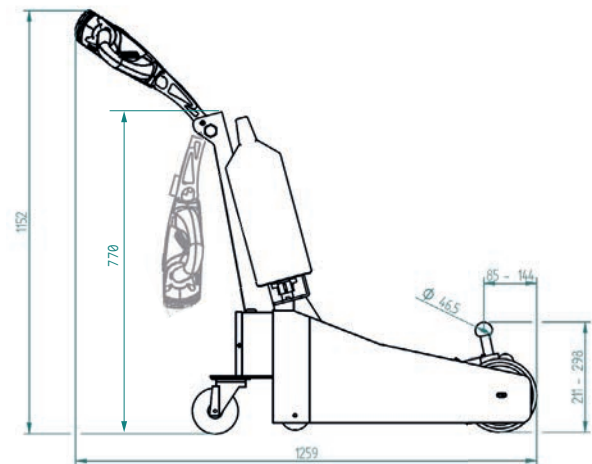
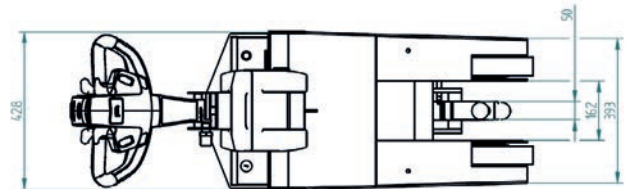

Standard parts

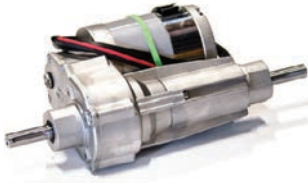

Motor 300W / 100rpm
(6911345X) without brake
Item number M1032



LED battery indicator
Item number M0123



Charger (external)
AGM battery 24V / 5A
Item number OPT0009



Battery AGM-VRLA green
24V / 22Ah
Item number OPT0110



Drive wheel
Ø 200 x 50 mm
Item number M0340



Castor wheel
Black Ø 125 mm
Item number M0110

Standard parts



Adjustable tiller head
Item no M1002-0100



Belly button RED
Item number M0121-BBUT



2 programmable speeds

Options



Horn 90dB for
steel tiller head supp.
M1002-0100
Item number OPT0057



Horn 103dB
Item number OPT0059

Options



Emergency stop complete
Item number OPT0063



Strobe light for
steel tiller head supp.
M1002-0100
Item number OPT0065

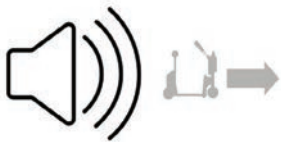

Audio signal
(while driving)
Item number OPT0253

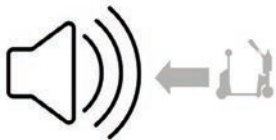

Audio signal
(driving backward)
Item number OPT0254



Electromagnetic
parkingbrake
Item number OPT0004



Hour tracker
Item number OPT0056

Options



Antistatic strip
Item number OPT0058



Code lock
Item number OPT0068

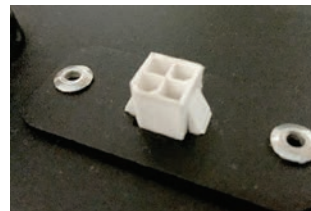

Diagnostic connector
Item number OPT0270



Ignition key (unequal)
Item number OPT0145



Ignition key 701 (equal)
Item number OPT0146



On/off rotary switch
Item number OPT0016

Options



Parking floorlabel Ø 60 cm
Item number OPT0245



Customized programming
Please indicate specific settings
Item number OPT0170



Programmer for Italsea
Item number D0003

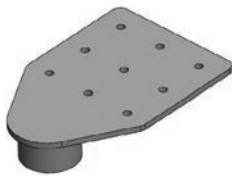

Screw tube
Item number OPT0301

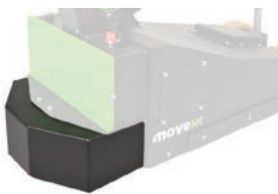

Safety fender
Item number OPT0212



Urgent order purchase
Item number SPOED

Batteries and Chargers



Battery AGM-VRLA green
24V / 22Ah
Item number OPT0110



Charger (external)
AGM battery 24V / 5A
Item number OPT0009



Battery Lithium green
(LiFePO4) 25,6V / 36Ah
Item number OPT0106



Charger (external)
Lithium battery 25,6V / 10A
Item number OPT0013



UPGRADE:
(only with new machines)
Battery Lithium (LiFePO4)
+ charger
Item number OPT0107



Wall mounted AGM
charger, incl. AGM
charger 24V / 5A
Item number OPT0015

Batteries and Chargers



Wall mounted Lithium charger, incl. Lithium charger 25,6V / 10A
Item number OPT0023



Charging station Lithium (5x), incl. Lithium charger 25,6V / 10A
Item number OPT0029



Charging station AGM (5x), incl. AGM charger 24V / 5A
Item number OPT0039



UPGRADE:
(only with new machines)
Wall mounting for charger (for AGM or Lithium)
Item number OPT0261

Most common spareparts



Charger (external) AGM battery 24V / 5A
Item number OPT0009



Battery Lithium green (LiFePO4) 25,6V / 36Ah
Item number OPT0106



Charger (external) Lithium battery 25,6V / 10A
Item number OPT0013



Battery guide (stainless steel)
Item number M0482



Battery connector SB50
Item number M0105

Most common spareparts



Battery AGM-VRLA green 24V / 22Ah
Item number OPT0110



Belly button RED
Item number M0121-BBUT

Most common spareparts



Switch buttons (2x) green
Item number
M0121-KNOP-GROEN



Switch tiller head
excl. buttons
Item number
M0121-FLIPPER



Feather/shaft Throttle
Item number **M0121-4**



Switch FAST/SLOW
tiller head green
Item number
M0121-SPEED-GROEN



Switch UP/DOWN
tiller head green
Item number
M0121-UPDOWN-GROEN



Plain sleeve bearing
Ø8 / 12 x 6, 16 x 2 mm
Item number **M4038**

Most common spareparts



Locking pin
M16 x 1,5 mm
Item number **M0001**



Coverplate tiller head
Item number **M0898**



Italsea drive controller
in 24V / 36 bat,
in 10A / I_{max} 45A
Item number **M1122-SP**



Carbon brushes (set of 4)
for Motor 300W
Item number **M0186**



LED battery indicator
Item number **M0123**



Cable harness complete
Item number **M1127-M050**

Most common spareparts



Fuse 5A
Item number M0506



Fuse Maxi 40A
Item number M0254



Drive wheel
Ø 200 x 50 mm
Item number M0340

Most common spareparts



Wheel
Black Ø 80 mm
Item number M0319



Castor wheel
Black Ø 125 mm
Item number M0110

applications



moveXX
driven by brain power

Generatorstraat 17-19
3903 LH Veenendaal
The Netherlands

T +31 (0)318 519900
E info@movexx.com
W www.movexx.com

