



Movexx **T1000-D**
PARTS & OPTIONS
2020 v2

Specifications

Technical details

Frame	Steel, powder coated
Drive	24V DC, 300W, 100 rpm
Weight	100 kg (220.5 lbs)
Max. pulling force	800 Ng
Weight trailer	Max. 1000 kg (2204.5 lbs)
Battery	Exchangeable battery pack
Speed Max.	5 km/h (3.1 mph)
Drive wheels	Full rubber Ø 250 x 80 mm (9.8 x 3.1 in)
Adze height	770-1152 mm (30.3 - 45.4 in)
Noise level	63,8 dB
To use from	-10° / 40° C (14° / 104° F)

© 2020 Movexx International B.V. The images shown are used for illustration purposes only and may differ from the products indicated. No rights can therefore be derived from it. Printing errors are subjected to change. The datasheet is the confidential product of Movexx International B.V. and no portion of this datasheet may be copied, performed, or redistributed without the express written authority of Movexx International B.V.

Pulling power (in kg)

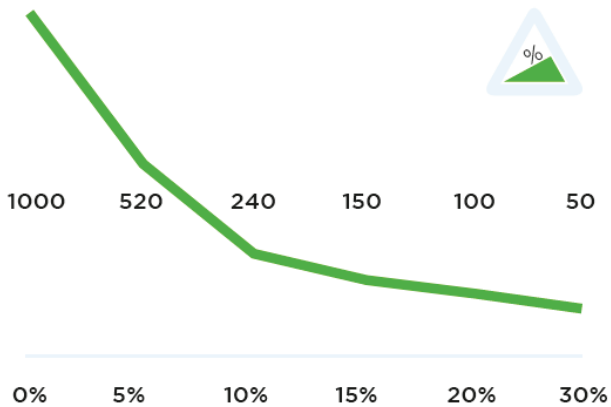

Measured with a trolley with 2 swivel wheels and 2 fixed castors. Wheel Ø 160 mm.

Dimensions

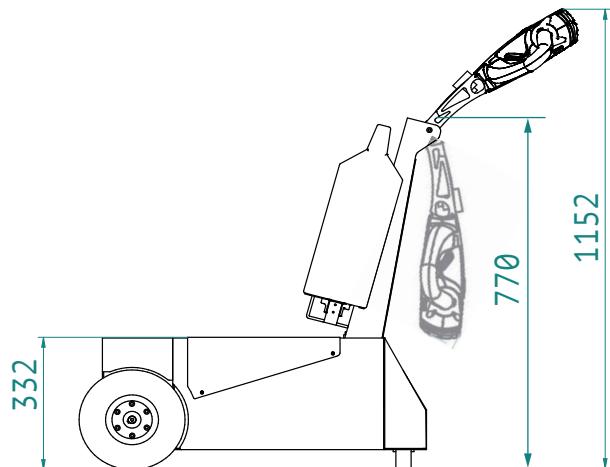
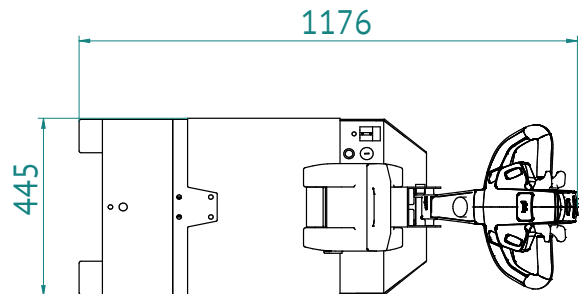

Standard parts



Motor 300W / 100rpm
(6911345X) without brake
Item number M1032



LED battery indicator
Item number M0123



Charger (external)
AGM battery 24V / 5A
Item number OPT0009



Battery AGM-VRLA green
24V / 22Ah
Item number OPT0110



Drive wheel, full rubber
Black Ø 250 x 80 mm
Item number M0248



Castor wheel
Black Ø 125 mm
Item number M0110

Standard parts



Adjustable tiller head
Item no M1002-0100



Belly button RED
Item number M0121-BBUT



2 programmable speeds

Options



Extra plug to recharge
the battery
*for on-machine battery
charging*
Item number OPT0001



UPGRADE:
(only with new machines)
Drive wheel full rubber,
non-marking
Gra 2x Ø 250 x 80mm
Item number OPT0359

Options



UPGRADE:
(only with new machines)
Drive wheel, foam filled
Black 2x Ø 250 x 80 mm
Item number OPT0360



UPGRADE:
(only with new machines)
Drive wheel foam filled,
non-marking
Grey 2x Ø 250 x 80 mm
Item number OPT0361



Horn 90dB for
steel tiller head supp.
M1002-0100
Item number OPT0057



Horn 103dB
Item number OPT0059



Emergency stop complete
Item number OPT0063



Strobe light for
steel tiller head supp.
M1002-0100
Item number OPT0065

Options



Strobe light on pole
Item number OPT0124



Audio signal
(while driving)
Item number OPT0253

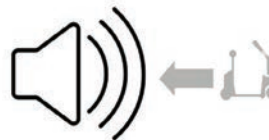

Audio signal
(driving backward)
Item number OPT0254



Remote set
4 channel, 2,4 GHz
Item number OPT0505



Electromagnetic
parking brake
Item number OPT0004



Hour tracker
Item number OPT0056

Options



Antistatic strip
Item number OPT0058



Code lock
Item number OPT0068



Document holder for
steel tiller head supp.
M1002-0100
Item number OPT0053



Preparation electric hook
Item number OPT0143

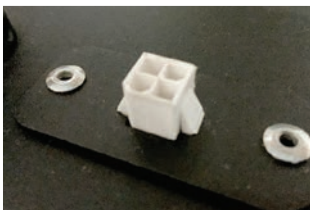

Diagnostic connector
Item number OPT0270



Ignition key (unequal)
Item number OPT0145

Options



Ignition key 701 (equal)
Item number OPT0146



On/off rotary switch
Item number OPT0016



Parking floorlabel Ø 60 cm
Item number OPT0245



Customized programming
*Please indicate
specific settings*
Item number OPT0170



Programmer for Italsea
Item number D0003



Maximum weight
Item number OPT0172

Options



U-frame for waste container 1000 l. / 1100 l.
Item number OPT0088



Adaptor for 2 wheel bins
Item number OPT0151

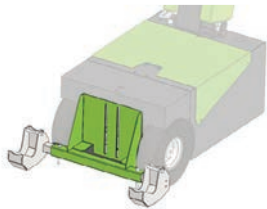

Adaptor for shopping trolley (90°)
Item number OPT0324

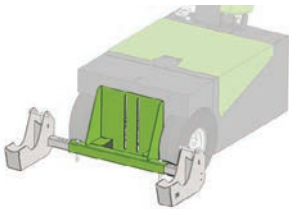

Adaptor for airport trolley (90°)
Item number OPT0327

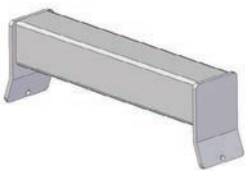

Welding part for trolley (profile 50x50mm)
Item number OPT0032



Bolt-on part for trolley (profile 50x50mm)
Item number OPT0033

Options



Pushbar
Item number OPT0048



Urgent order purchase
Item number SPOED

Batteries and chargers



Battery AGM-VRLA green
24V / 22Ah
Item number OPT0110



Charger (external)
AGM battery 24V / 5A
Item number OPT0009



Battery lithium green
(LiFePO4) 25,6V / 36Ah
Item number OPT0106

Batteries and chargers



Charger (external)
Lithium battery 25,6V / 10A
Item number OPT0013



UPGRADE:
(only with new machines)
Battery Lithium (LiFePO4)
+ charger
Item number OPT0107



Wall mounted AGM
charger, incl. AGM
charger 24V / 5A
Item number OPT0015



Wall mounted Lithium
charger, incl. Lithium
charger 25,6V / 10A
Item number OPT0023



Charging station Lithium
(5x), incl. Lithium
charger 25,6V / 10A
Item number OPT0029



Charging station AGM
(5x), incl. AGM
charger 24V / 5A
Item number OPT0039

Batteries and chargers



UPGRADE:
(only with new machines)
Wall mounting for charger
(for AGM or Lithium)
Item number OPT0261

Adapters



Base part hook 90°
Item number H7030



Base part hook 90°
(double spring)
Item number H7040



Base part HD hook 90°
(lowered)
Item number H7070

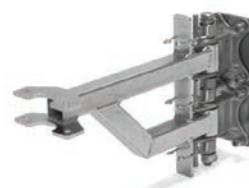

Base part HD hook 90°
(raised)
Item number H7080

Adapters



Base part hook 90°
(manual controle)
Item number H7090



Angle limitation hook 90°
Item number OPT0244

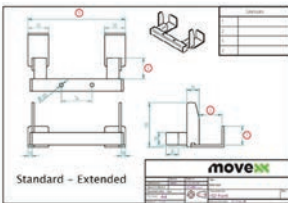

Customized hook
Please complete corresponding sheet
Item number HA5000

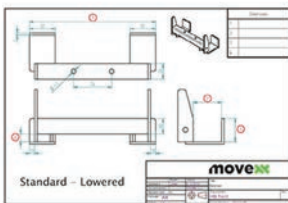

Customized hook (low)
Please complete corresponding sheet
Item number HB5000

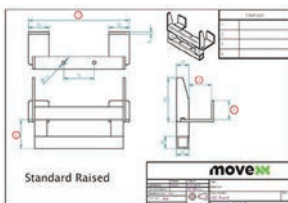

Customized hook (raised)
Please complete corresponding sheet
Item number HC5000

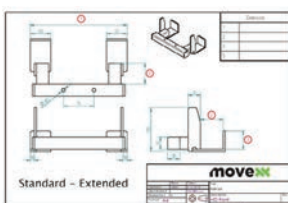

Customized hook (extended)
Please complete corresponding sheet
Item number HD5000

Adapters

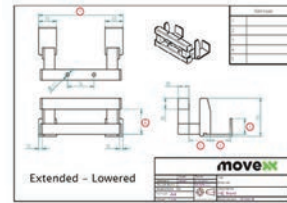

Customized hook (extended/low)
Please complete corresponding sheet
Item number HE5000

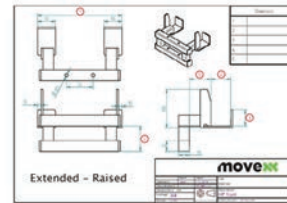

Customized hook (extended/raised)
Please complete corresponding sheet
Item number HF5000



Hitch ball Ø 50mm
(incl. adapter)
Item number H0068



Hook for LKE platform-wagon (type X)
Item number H0076



Hook K-Hartwall dolly (DOS1617/1636, 90°)
Item number H0083



Electric lifting module for hook
Item number OPT0050

Adapters

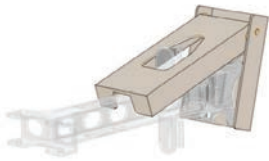

Hook locking system
stainless steel
Item number OPT0012



Electric locking module
for hook
Item number OPT0129



Pen for drawbar Ø16
Item number H0064

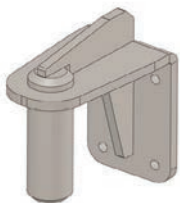

Pen for drawbar Ø35
Item number H0144



Pen for drawbar Ø20
Item number H0161



Pen for drawbar Ø25
Item number H0166

Adapters



Trailer coupling, pen Ø25
Item number H0062



Trailer coupling, pen Ø32
Item number H0146



Trailer coupling, pen Ø25
Item number H0149



Towbar for Movexx
e-frame
(suitable for OPT0067)
Item number H0070

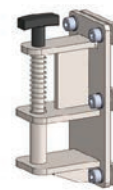

Spring hitch, pen Ø16
Item number H0120



Pen for drawbar Ø15
Item number H0071

Adapters



Pen for drawbar Ø10
Item number H0072



Folding hook
for flower trolley
Item number OPT0099



Folding hook Ø16
Item number H0128-D16



Folding hook Ø20
Item number H0128-D20



Folding hook Ø25
Item number H0128-D25



Folding hook Ø27
Item number H0128-D27

Adapters



Folding hook Ø32
Item number H0128-D32



Folding hook Ø35
Item number H0128-D35

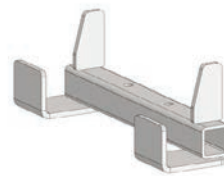

HA270.43.40.0.0
Hook for 40 mm profile
(K-Hartwall pallet trolley;
DOS1870)
Item number H0003

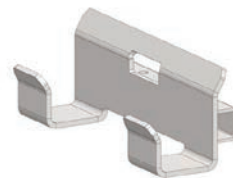

HA245.53.45.15.0
Hook for 50 mm profile
(heavy duty)
Item number H0004

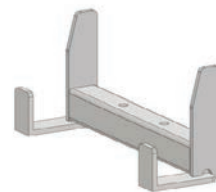

HA250.43.35.0.0
Hook for 40 mm profile
Item number H0051

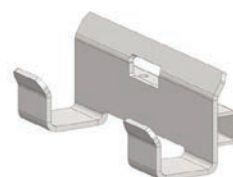

HB245.43.30.5.0
Hook for 40 mm profile
Item number H0054

Adapters

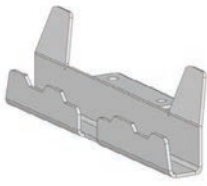

HA250.23.27.0.0
Hook for 20 mm profile
Item number H0067

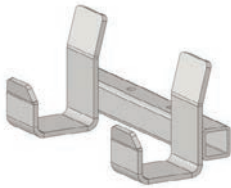

HB245.60.45.30.0
Hook for FEIL plastic floor
trolley
Item number H0092



HA250.28.25.0.0
Hook for 25 mm profile
Item number H0094

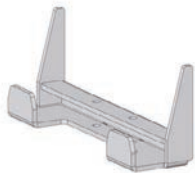

HA250.33.30.0.0
Hook for 30 mm profile
Item number H0095

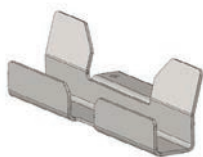

HA250.35.30.0.0
Hook for 30 mm profile
(furniture trolley)
Item number H0097

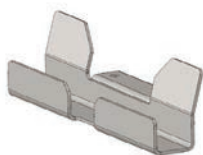

HF242.23.30.15.20
Hook for 20 mm profile
(hospital logistics)
Item number H0116

Most common spareparts



Battery AGM-VRLA green
24V / 22Ah
Item number OPT0110



Charger (external)
AGM battery 24V / 5A
Item number OPT0009



Battery Lithium green
(LiFePO4) 25,6V / 36Ah
Item number OPT0106



Charger (external)
Lithium battery 25,6V / 10A
Item number OPT0013



Battery guide
(stainless steel)
Item number M0482



Battery connector SB50
Item number M0105

Most common spareparts



Belly button RED
Item number M0121-BBUT



Switch buttons (2x) green
Item number M0121-KNOP-GROEN



Switch tiller head
excl. buttons
Item number M0121-FLIPPER



Feather/shaft Throttle
Item number M0121-4



Switch FAST/SLOW
tiller head green
Item number M0121-SPEED-GROEN



Switch ON/OFF
tiller head green
Item number M0121-AANUIT-GROEN

Most common spareparts



Plain sleeve bearing
Ø8 / 12 x 6, 16 x 2 mm
Item number M4038



Locking pin
M16 x 1,5 mm
Item number M0001



Coverplate tiller head
Item number M0898



Torsion spring for hook
Item number M0116-SP



Italsea drive controller
in 24V / 36 bat,
in 10A / I_{max} 45A
Item number M1122-SP



Carbon brushes (set of 4)
for Motor 300W
Item number M0186

Most common spareparts



LED battery indicator
Item number M0123



Cable harness complete
Item number M1127-M050



Fuse 5A
Item number M0506



Fuse Maxi 80A
Item number M0191

Most common spareparts



Drive wheel, full rubber
Black Ø 250 x 80 mm
Item number M0248



Drive wheel
full rubber, non-marking
Gray Ø 250 x 80 mm
Item number M0115



Drive wheel, foamed at 2b
Black Ø 250 x 80 mm
Item number M0091



Castor wheel
Black Ø 125 mm
Item number M0110

applications



movexx
driven by brain power

Generatorstraat 17-19
3903 LH Veenendaal
The Netherlands

T +31 (0)318 519900
E info@movexx.com
W www.movexx.com

