



Movexx **T1000-Basic**
PARTS & OPTIONS
2020

Specifications

Technical details

Frame	Steel, powder coated
Drive	24V DC, 300W, 100 rpm
Weight	40 kg (88.2 lbs)
Max. pulling force	800 N
Weight trailer	Max. 1000 kg (2204.5 lbs)
Battery	Built in
Speed Max.	5 km/h (3.1 mph)
Drive wheels	Full rubber Ø 250x80mm (9.8 x 3.1 in)
Adze height	1056 mm (41.6 in)
Noise level	63,8 dB
To use from	-10° / 40° C (14°/ 104° F)

© 2020 Movexx International B.V. The images shown are used for illustration purposes only and may differ from the products indicated. No rights can therefore be derived from it. Printing errors are subjected to change. The datasheet is the confidential product of Movexx International B.V. and no portion of this datasheet may be copied, performed, or redistributed without the express written authority of Movexx International B.V.

Pulling power (in kg)

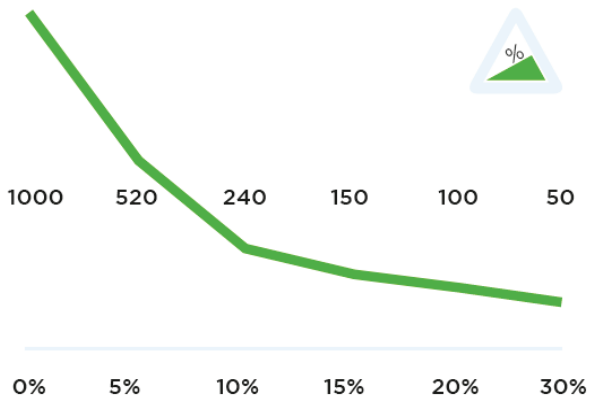

Measured with a trolley with 2 swivel wheels and 2 fixed castors. Wheel Ø 160 mm.

Dimensions

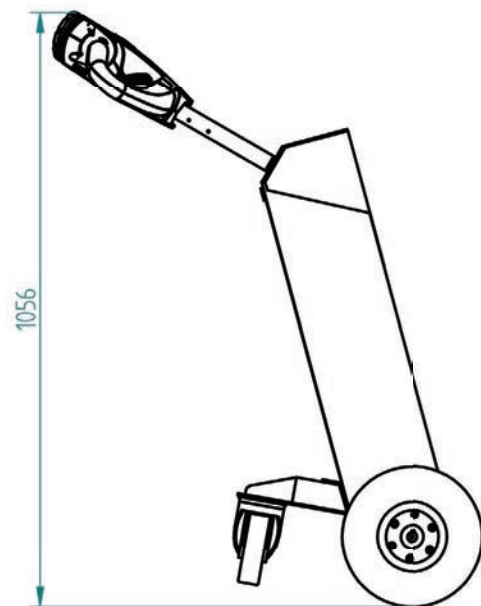
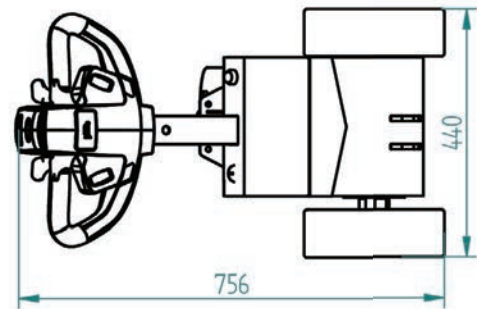

Standard parts

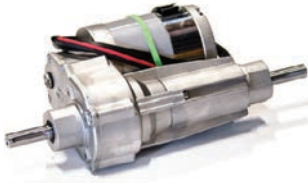

Motor 300W / 100rpm
(6911345X) without brake
Item number M1032



Battery AGM-VRLA block
24V / 22Ah
Item number M0076-SP



LED battery indicator
(build-in)
Item number M0318



Charger (internal)
AGM battery 24V / 5A
+ external indicator
Item number M0246



Drive wheel, full rubber
Black Ø 250 x 80 mm
Item number M0248



Belly button RED
Item number M0121-BBUT

Standard parts



2 programmable speeds

Options



UPGRADE:
(only with new machines)
Drive wheel full rubber,
nonmarking
Gray 2x Ø 250 x 80 mm
Item number OPT0359



UPGRADE:
(only with new machines)
Drive wheel, foam filled
Black 2x Ø 250 x 80 mm
Item number OPT0360



UPGRADE:
(only with new machines)
Drive wheel foam filled,
non marking
Gray 2x Ø 250 x 80 mm
Item number OPT0361



Horn 90dB for
steel tiller head supp.
M1002-0100
Item number OPT0057

Options



Horn 103dB
Item number OPT0059



Emergency stop complete
Item number OPT0063



Strobelight for
steel tiller head supp.
Item number OPT0065



Audio signal
(while driving)
Item number OPT0253

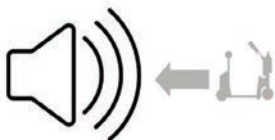

Audio signal
(driving backward)
Item number OPT0254



Tool/coupling box
Item number OPT0014

Options



Electromagnetic
parking brake
Item number OPT0004

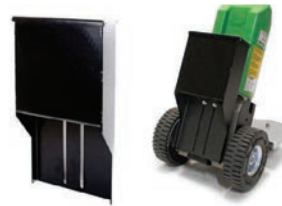

Counterweight (front)
30kg
Item number OPT0044



Hour tracker
Item number OPT0056



Antistatic strip
Item number OPT0058



Code lock
Item number OPT0068



Document holder for
steel tiller head supp.
Item number OPT0053

Options



Storage system
(incl. snap hooks) for
steel tiller head supp.
Item number OPT0482



Preparation electric hook
Item number OPT0143

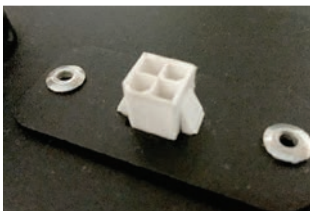

Diagnostic connector
Item number OPT0270



Ignition key (unequal)
Item number OPT0145



Ignition key 701 (equal)
Item number OPT0146



On/off rotary switch
Item number OPT0016

Options



Parking floorlabel Ø 60 cm
Item number OPT0245



Customized programming
*Please indicate
specific settings*
Item number OPT0170



Programmer for Italsea
Item number D0003



Frame for
4-wheel waste container
Item number OPT0085

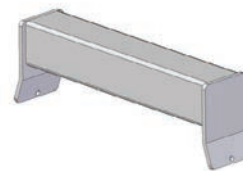

Welding part for trolley
(profile 50 x 50 mm)
Item number OPT0032



Bolt-on part for trolley
(profile 50 x 50 mm)
Item number OPT0033

Options



Attachment for trolley
Caddie/Wanzl
Item number OPT0040



Frame for
770 l. and 240 l. container
Item number OPT0375

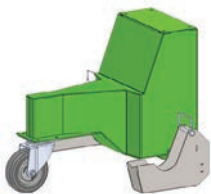

Adaptor for
airport trolley
Item number OPT0325



Adaptor for
shopping trolley
Item number OPT0326



Urgent order purchase
Item number SPOED



Battery AGM-VRLA block
24V / 22Ah
Item number M0076-SP

Batteries and Chargers



Charger (internal)
AGM battery 24V / 5A
+ external indicator
Item number M0246

Adapters



Base part hook 15°
Item number H7010



Base part hook 15°
(double spring)
Item number H7020



Angle limitation hook 15°
Item number OPT0218

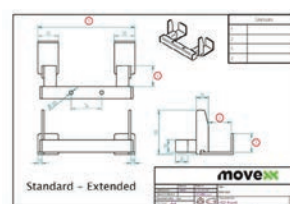

Customized hook
*Please complete
corresponding sheet*
Item number HA5000

Adapters

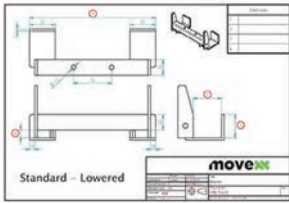

Customized hook (low)
*Please complete
 corresponding sheet*
Item number HB5000

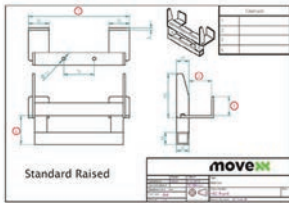

Customized hook (raised)
*Please complete
 corresponding sheet*
Item number HC5000

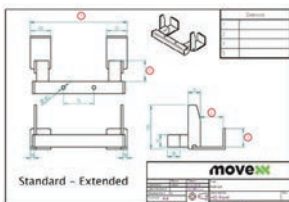

Customized hook
 (extended)
*Please complete
 corresponding sheet*
Item number HD5000

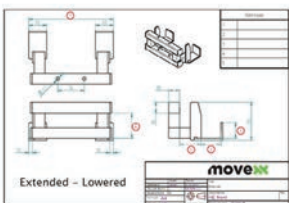

Customized hook
 (extended/low)
*Please complete
 corresponding sheet*
Item number HE5000

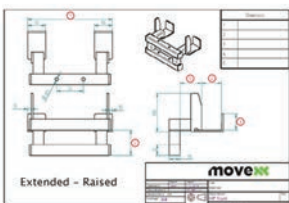

Customized hook
 (extended/raised)
*Please complete
 corresponding sheet*
Item number HF5000



Hook for LKE platform-
 wagon (type X)
Item number H0076

Adapters

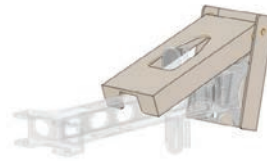

Hook locking system
 stainless steel
Item number OPT0012



Electric lifting module
 for hook
Item number OPT0050



Electric locking module
 for hook
Item number OPT0129



Clamping hook
 (stainless steel)
Item number H0096



Clamping hook (HD)
 (range: 0 - 100mm)
Item number H0152



Tilting clamping hook for
 wooden profile 145x20mm
 Self-aligning connection,
 pivoting angle 15° up/down
Item number H0170

Adapters

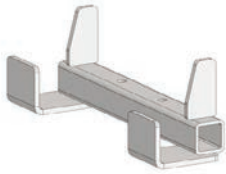

HA270.43.40.0.0
Hook for 40 mm profile
(K-Hartwall pallet trolley;
DOS1870)
Item number H0003

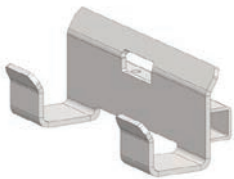

HA245.53.45.15.0
Hook for 50 mm profile
(heavy duty)
Item number H0004

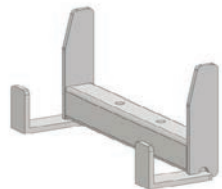

HA250.43.35.0.0
Hook for 40 mm profile
Item number H0051

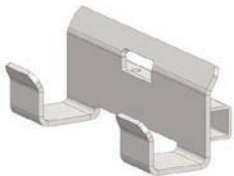

HB245.43.30.5.0
Hook for 40 mm profile
Item number H0054

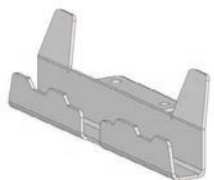

HA250.23.27.0.0
Hook for 20 mm profile
Item number H0067

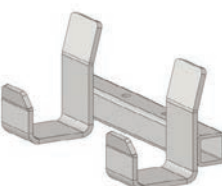

HB245.60.45.30.0
Hook for FEIL plastic floor
trolley
Item number H0092

Adapters

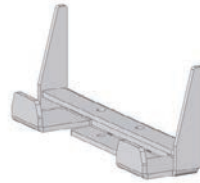

HA250.28.25.0.0
Hook for 25 mm profile
Item number H0094

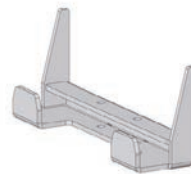

HA250.33.30.0.0
Hook for 30 mm profile
Item number H0095

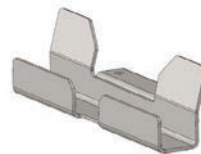

HF242.23.30.15.20
Hook for 20 mm profile
(hospital logistics)
Item number H0116

Most common spareparts



Battery AGM-VRLA block
24V / 22Ah
Item number M0076-SP



Charger (internal)
AGM battery 24V / 5A
+ external indicator
Item number M0246

Most common spareparts



Belly button RED
Item number M0121-BBUT



Switch buttons (2x) green
Item number M0121-KNOP-GROEN



Switch tiller head
excl. buttons
Item number M0121-FLIPPER



Feather/shaft Throttle
Item number M0121-4



Switch FAST/SLOW
tiller head green
Item number M0121-SPEED-GROEN



Switch ON/OFF
tiller head green
Item number M0121-AANUIT-GROEN

Most common spareparts



Torsion spring for hook
Item number M0116-SP



Clamping hook (HD)
(range: 0 - 100mm)
Item number H0152-SP



Italsea drive controller
in 24V / 36 bat,
in 10A / I_{max} 45A
Item number M1122-SP



Carbon brushes (set of 4)
for Motor 300W
Item number M0186



LED battery indicator
(build-in)
Item number M0318



Cable harness 3
Item number M1133

Most common spareparts



Chassis cable charger
Item no M0158-Stekker



Fuse 5A
Item number M0506



Fuse Maxi 40A
Item number M0254

Most common spareparts



Drive wheel, full rubber
Black Ø 250 x 80 mm
Item number M0248



Castor wheel
Black Ø 125 mm
Item number M0110

applications



movexx
driven by brain power

Generatorstraat 17-19
3903 LH Veenendaal
The Netherlands

T +31 (0)318 519900
E info@movexx.com
W www.movexx.com

